

Top View

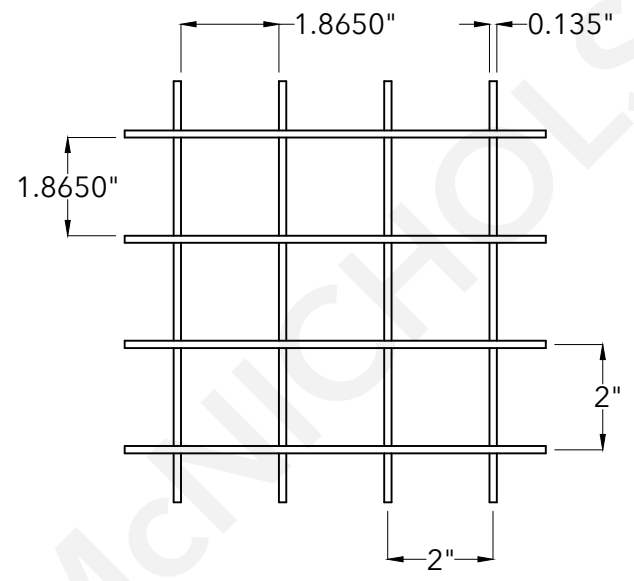

End View

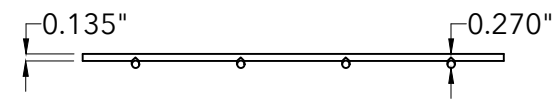

McNICHOLS®
800.237.3820 mcnichols.com

Drawing is for visual and conceptual purposes, is not to scale, and is based on nominal manufacturing data subject to standard production tolerances. **McNICHOLS CO.** does not provide engineering services of any kind. Technical information provided is for evaluation by technically skilled persons only, with any use thereof to be at their independent discretion and risk. **McNICHOLS CO.** shall have no responsibility or liability for results obtained or damages resulting from improper evaluation or use. **McNICHOLS CO.** makes no representation or warranty of any kind, express or implied, at law or in equity, regarding drawing including with respect to merchantability, fitness for any particular use or purpose, or design. All other representations or warranties are hereby disclaimed. This document and other related documents are subject to **McNICHOLS CO.** Terms and Conditions.

McNICHOLS® WIRE MESH

MESH TYPE	Square Mesh
CONSTRUCTION TYPE	Welded
PRIMARY MATERIAL	Carbon Steel
WEAVE or TRIM TYPE	Welded - Untrimmed
PERCENT OPEN AREA	87%
A MESH SIZE	2" x 2"
B OPENING SIZE	1.8650" x 1.8650"
C WIRE DIAMETER/WIRE GAUGE	0.135" Thick (10 Gauge)

DRAWING

NOT TO SCALE
Item Number 36209000
Revision Date 02.18.2021
Page Number 1 of 1
© 2021 **McNICHOLS CO.**
All Rights Reserved.