

Top View

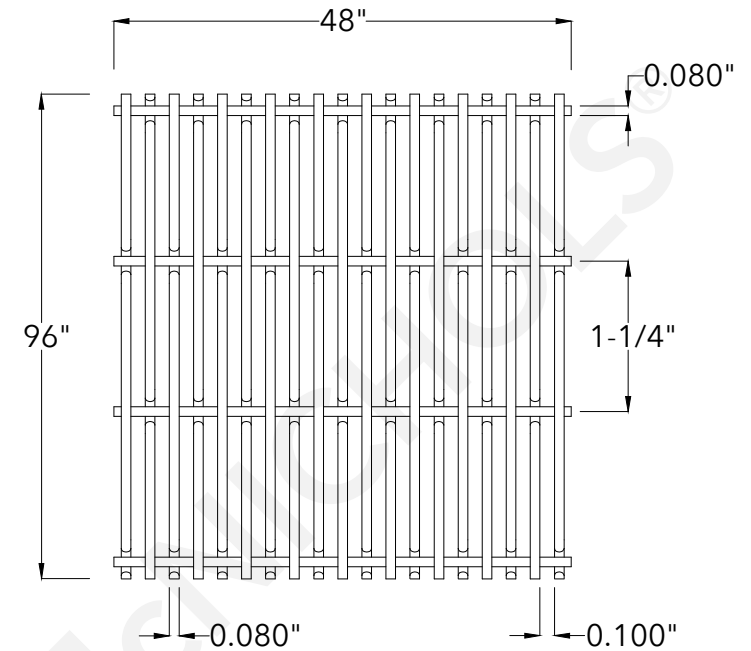

End View

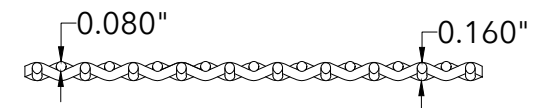

800.237.3820  
mcnichols.com

McNICHOLS® WIRE MESH

DRAWING

Drawing is for visual and conceptual purposes, is not to scale, and is based on nominal manufacturing data subject to standard production tolerances. McNICHOLS CO. does not provide engineering services of any kind. Technical information provided is for evaluation by technically skilled persons only, with any use thereof to be at their independent discretion and risk. McNICHOLS CO. shall have no responsibility or liability for results obtained or damages resulting from improper evaluation or use. McNICHOLS CO. makes no representation or warranty of any kind, express or implied, at law or in equity, regarding drawing including with respect to merchantability, fitness for any particular use or purpose, or design. All other representations or warranties are hereby disclaimed. This document and other related documents are subject to McNICHOLS CO. Terms and Conditions.

CONSTRUCTION TYPE	Designer Woven
SERIES NAME & NUMBER	SHIRE™ 4391
WEAVE TYPE	Woven - Flat Top Weave
PRIMARY MATERIAL	Stainless Steel
PERCENT OPEN AREA	52%
WIRE DIAMETER PARALLEL TO LENGTH	0.080"
WIRE DIAMETER PARALLEL TO WIDTH	0.080"
A MAXIMUM LENGTH	96"
B MAXIMUM WIDTH	48"
C MAXIMUM OPENING	0.100"

NOT TO SCALE

Item Number 3843910048

Revision Date 01.09.2025

Page Number 1 of 1

© 2025 McNICHOLS CO.  
All Rights Reserved.