

Top View

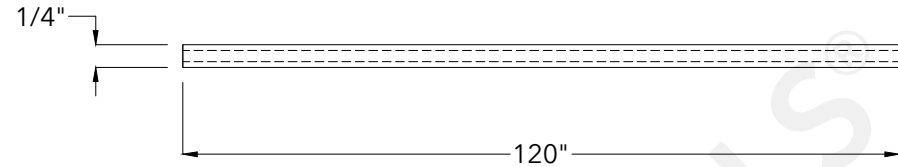

End View

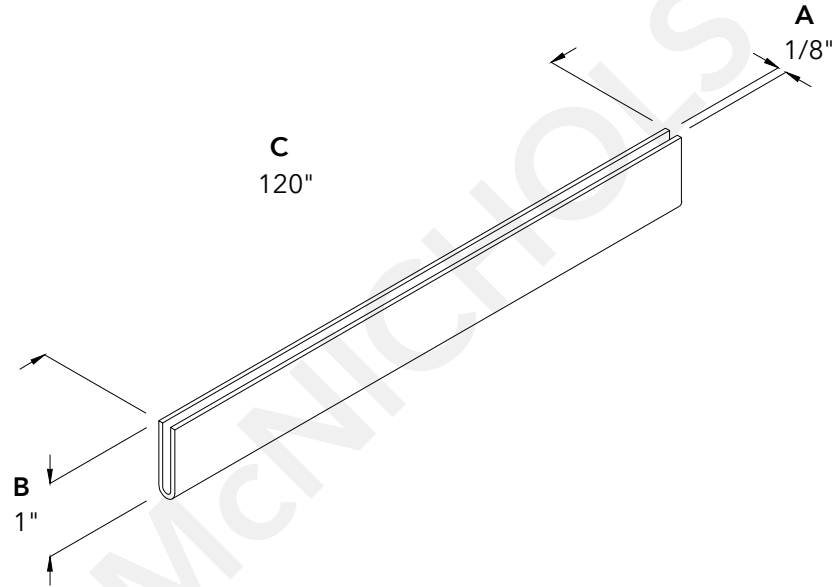
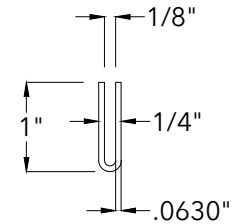

McNICHOLS®

800.237.3820

mcnichols.com

Drawing is for visual and conceptual purposes, is not to scale, and is based on nominal manufacturing data subject to standard production tolerances. **McNICHOLS CO.** does not provide engineering services of any kind. Technical information provided is for evaluation by technically skilled persons only, with any use thereof to be at their independent discretion and risk. **McNICHOLS CO.** shall have no responsibility or liability for results obtained or damages resulting from improper evaluation or use. **McNICHOLS CO.** makes no representation or warranty of any kind, express or implied, at law or in equity, regarding drawing including with respect to merchantability, fitness for any particular use or purpose, or design. All other representations or warranties are hereby disclaimed. This document and other related documents are subject to **McNICHOLS CO.** Terms and Conditions.

McNICHOLS® ACCESSORIES

ACCESSORY TYPE	U-Edging
PRIMARY MATERIAL	Aluminum
GAUGE/THICKNESS	.0630" Thick (14 Gauge)
ACCESSORY PROFILE	Type 402 U-Edging (1/8" Opening x 1" Width)
COMPATIBLE WITH	Used to Frame the Edges of Aluminum Perforated Metal, Expanded Metal and Wire Mesh
A OPENING (CLEAR SPACE)	1/8"
B WIDTH	1"
C LENGTH	120"

DRAWING

NOT TO SCALE

Item Number 4071440210

Revision Date 10.27.2021

Page Number 1 of 1

© 2021 **McNICHOLS CO.**
All Rights Reserved.