

Top View

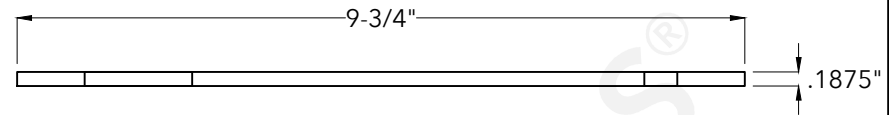

End View

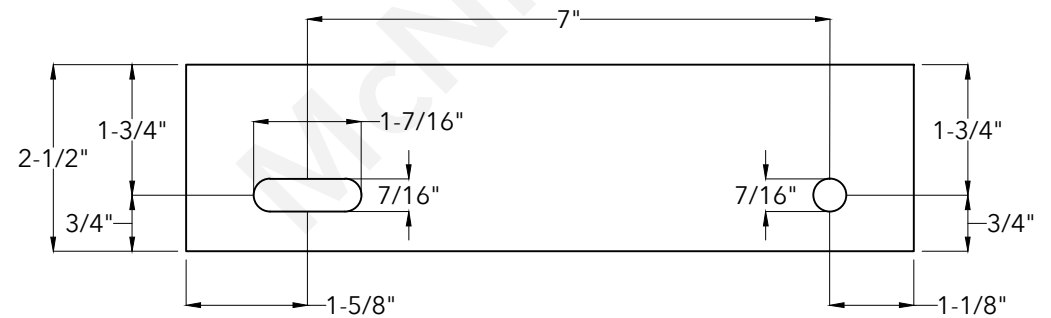

McNICHOLS®

800.237.3820

mcnichols.com

Drawing is for visual and conceptual purposes, is not to scale, and is based on nominal manufacturing data subject to standard production tolerances. **McNICHOLS CO.** does not provide engineering services of any kind. Technical information provided is for evaluation by technically skilled persons only, with any use thereof to be at their independent discretion and risk. **McNICHOLS CO.** shall have no responsibility or liability for results obtained or damages resulting from improper evaluation or use. **McNICHOLS CO.** makes no representation or warranty of any kind, express or implied, at law or in equity, regarding drawing including with respect to merchantability, fitness for any particular use or purpose, or design. All other representations or warranties are hereby disclaimed. This document and other related documents are subject to **McNICHOLS CO.** Terms and Conditions.

McNICHOLS® ACCESSORIES

ACCESSORY TYPE	Carrier Plates - Bar Grating
PRIMARY MATERIAL	Carbon Steel
ACCESSORY PROFILE	CP-BG-925 (2-1/2" Hgt x 9-3/4" Wd)
A GAUGE/THICKNESS	3/16" Gauge (.1875" Thick)
B HEIGHT	2-1/2"
C WIDTH	9-3/4"

DRAWING

NOT TO SCALE

Item Number 60003109
Revision Date 05.26.2020
Page Number 1 of 1

© 2020 **McNICHOLS CO.**
 All Rights Reserved.