

Top View

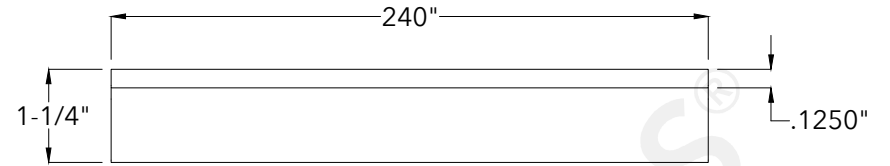

Side View



End View

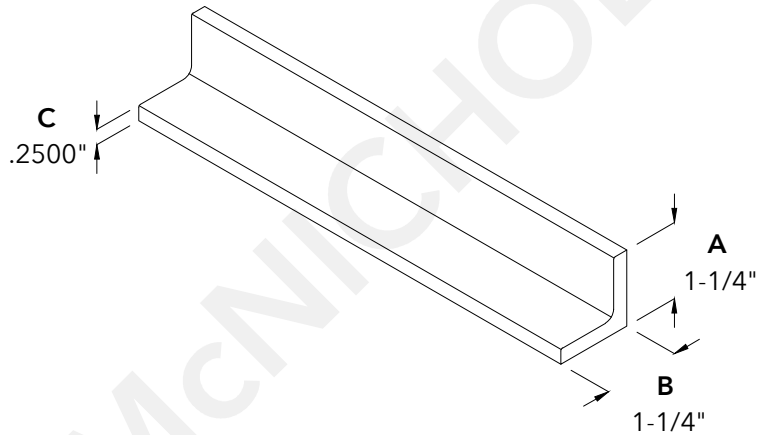
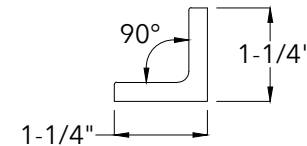

McNICHOLS®

800.237.3820

mcnichols.com

Drawing is for visual and conceptual purposes, is not to scale, and is based on nominal manufacturing data subject to standard production tolerances. **McNICHOLS CO.** does not provide engineering services of any kind. Technical information provided is for evaluation by technically skilled persons only, with any use thereof to be at their independent discretion and risk. **McNICHOLS CO.** shall have no responsibility or liability for results obtained or damages resulting from improper evaluation or use. **McNICHOLS CO.** makes no representation or warranty of any kind, express or implied, at law or in equity, regarding drawing including with respect to merchantability, fitness for any particular use or purpose, or design. All other representations or warranties are hereby disclaimed. This document and other related documents are subject to **McNICHOLS CO.** Terms and Conditions.

McNICHOLS® ACCESSORIES

PRODUCT LINE
ACCESSORY TYPE
PRIMARY MATERIAL
ACCESSORY PROFILE
COMPATIBLE WITH

Accessories
Angle
Carbon Steel
90° Angle
Used in the Fabrication of Carbon Steel Bar Grating and Used to Frame the Edges of Carbon Steel Perforated Metal, Expanded Metal and Wire Mesh
1-1/4"
1-1/4"
1/4" Thick (.2500" Thick)

A LEG
B LEG
C THICKNESS

DRAWING

NOT TO SCALE

Item Number 6012512720
Revision Date 01.18.2022
Page Number 1 of 1

© 2022 **McNICHOLS CO.**
All Rights Reserved.