

Clip Top View

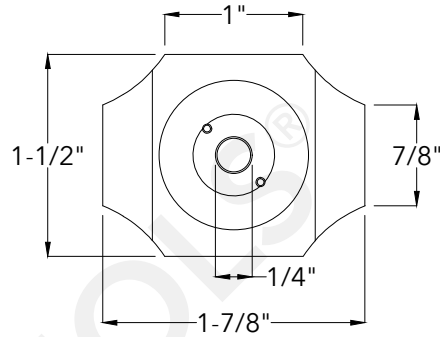

Clip Side View

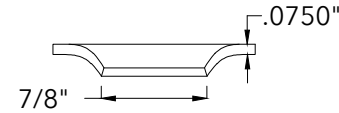

Clip End View

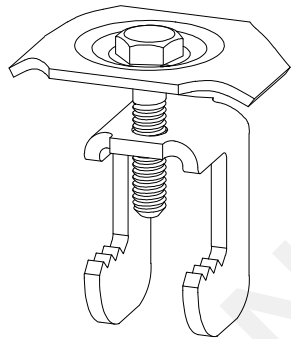
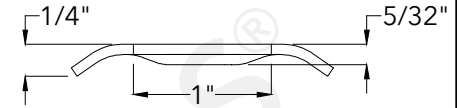

Base Top View

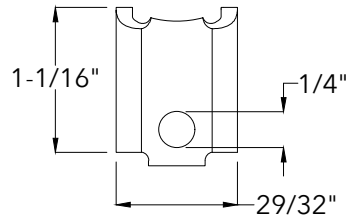

Base Side View

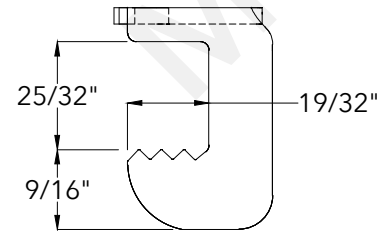

Base End View

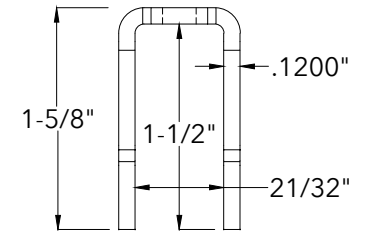

McNICHOLS®

800.237.3820

mcnichols.com

Drawing is for visual and conceptual purposes, is not to scale, and is based on nominal manufacturing data subject to standard production tolerances. **McNICHOLS CO.** does not provide engineering services of any kind. Technical information provided is for evaluation by technically skilled persons only, with any use thereof to be at their independent discretion and risk. **McNICHOLS CO.** shall have no responsibility or liability for results obtained or damages resulting from improper evaluation or use. **McNICHOLS CO.** makes no representation or warranty of any kind, express or implied, at law or in equity, regarding drawing including with respect to merchantability, fitness for any particular use or purpose, or design. All other representations or warranties are hereby disclaimed. This document and other related documents are subject to **McNICHOLS CO.** Terms and Conditions.

McNICHOLS® ACCESSORIES

ACCESSORY TYPE
PRIMARY MATERIAL
ACCESSORY PROFILE
COMPATIBLE WITH

Fastener
Galvanized Steel
Type GG1C Saddle Clip
Fits Carbon Steel and Galvanized Steel
Bar Grating with 1-1/2" Height Rectangular
Bearing Bars, Spaced 1-3/16" on Center
1/4" x 1-1/4" Hexagonal Bolt

HARDWARE

DRAWING

NOT TO SCALE

Item Number 60GG1C4099

Revision Date 12.21.2021

Page Number 1 of 1

© 2021 **McNICHOLS CO.**
All Rights Reserved.