

**Bar Grating**

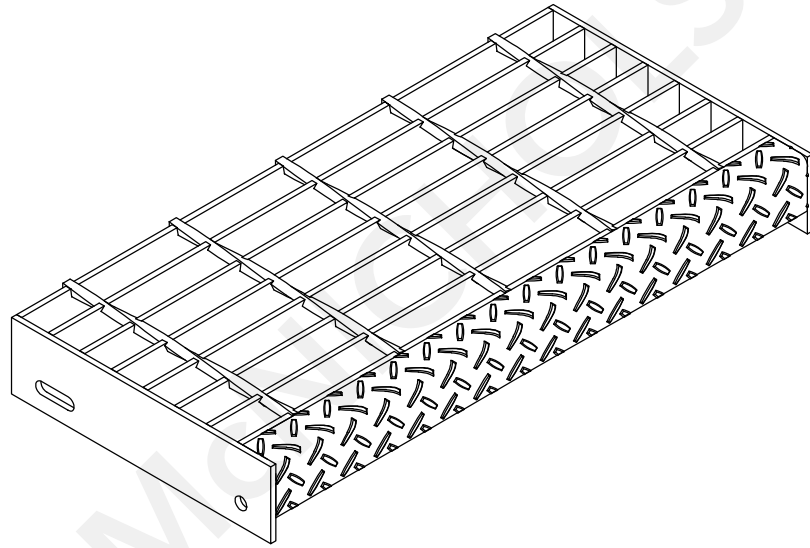

**Top View**

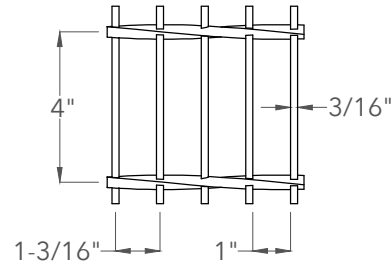

**End View**

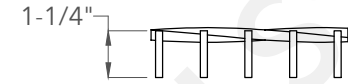

**Nosing**

**Top View**

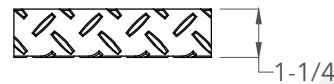

**Front View**



**End View**

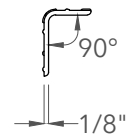

**Carrier Plate**

**Side View**

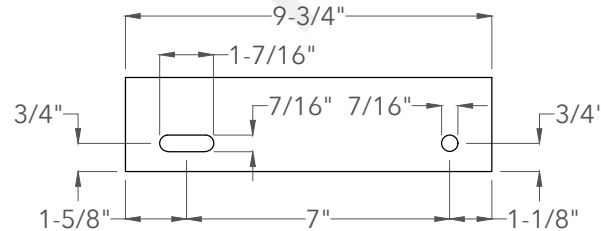

**End View**

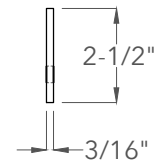

**McNICHOLS**

800.237.3820

[mcnichols.com](http://mcnichols.com)

Drawing is for visual and conceptual purposes, is not to scale, and is based on nominal manufacturing data subject to standard production tolerances. McNICHOLS CO. does not provide engineering services of any kind. Technical information provided is for evaluation by technically skilled persons only, with any use thereof to be at their independent discretion and risk. McNICHOLS CO. shall have no responsibility or liability for results obtained or damages resulting from improper evaluation or use. McNICHOLS CO. makes no representation or warranty of any kind, express or implied, at law or in equity, regarding drawing including with respect to merchantability, fitness for any particular use or purpose, or design. All other representations or warranties are hereby disclaimed. This document and other related documents are subject to McNICHOLS CO. Terms and Conditions.

**McNICHOLS® STAIR TREADS**

MAIN PRODUCT LINE  
 SERIES TYPE & NAME  
 PRODUCT SPACING  
 PRIMARY MATERIAL  
 BEARING BAR SIZE & SHAPE  
 BEARING BAR SPACING  
 CROSS BAR SPACING  
 PRODUCT SURFACE  
 NOSING  
 CARRIER PLATE

Bar Grating  
 Bar - GW-125 (Standard-Duty Welded)  
 19-W-4  
 Galvanized Steel  
 1-1/4" Height x 3/16" Thick Rectangular Bar  
 1-3/16" on Center  
 4" on Center  
 Smooth  
 Checkered Plate 90° Angle Nosing (1-1/4" Leg x 1-3/4" Leg)  
 CP-BG-925 Bar Grating Stair Tread Carrier Plates - Pair  
 (2-1/2" Height x 9-3/4" Width)

**DRAWING**

NOT TO SCALE

**Item Number** 640431T503

**Revision Date** 03.15.2022

**Page Number** 1 of 1

© 2022 McNICHOLS CO.  
 All Rights Reserved.