

SIDE VIEW

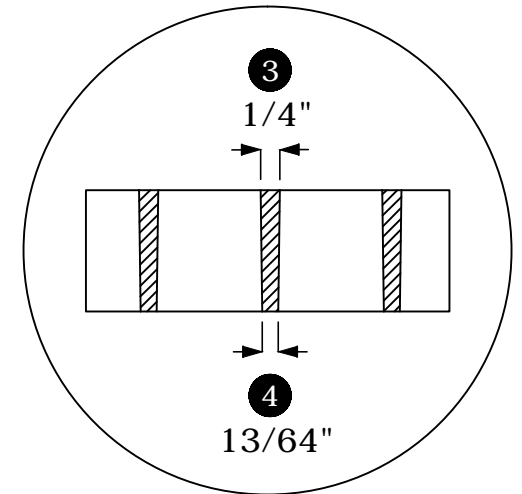

McNICHOLS CO.



McNICHOLS CO. has based these drawings on the data provided by you, and they are intended solely for visual and conceptual information purposes as part of the order process. ANY USE OF THESE DRAWINGS (INCLUDING DESIGN AND DIMENSIONS) MUST BE CHECKED BY YOUR ENGINEER TO DETERMINE WHETHER THE DRAWINGS (INCLUDING DESIGN AND DIMENSIONS) ARE ADEQUATE FOR THE INTENDED USE. McNICHOLS CO. makes no representation or warranty (express or implied) regarding such drawings and expressly disclaims all implied warranties regarding them including but not limited to any implied warranties of merchantability of fitness for a particular purpose. McNICHOLS CO. will in no event be liable for your use or the results of your use of these drawings, and you assume all risk and liability for any losses, damage, claims or expenses resulting from such use.

McNICHOLS® FIBERGLASS GRATING

CONSTRUCTION TYPE: Molded
 SERIES TYPE & NAME: MS-S-150
 GRID SHAPE: Square
 PRODUCT SURFACE: Concave
 PERCENT OPEN AREA: 70%
 ① GRID HEIGHT: 1-1/2"
 ② GRID SIZE: 1-1/2" x 1-1/2" on Center
 ③ GRID THICKNESS - TOP: 1/4"
 ④ GRID THICKNESS - BOTTOM: 13/64"

APPROVAL

JOB NAME:
 DATE:
 COMPANY:
 NAME:
 TITLE:
 SIGNATURE:

DRAWING INFORMATION

NOT TO SCALE	
DWG NUMBER	REVISION
F2611213	A

Inspired to Serve!®
 ©McNICHOLS CO. 2018